

电机驱动

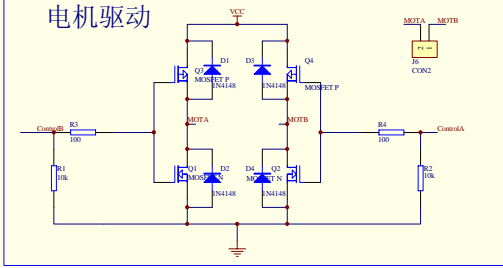

液晶显示

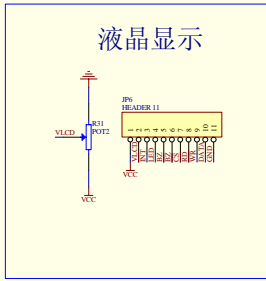

串口通讯

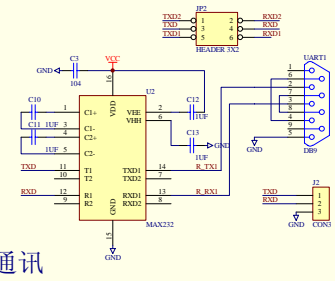

射频模块

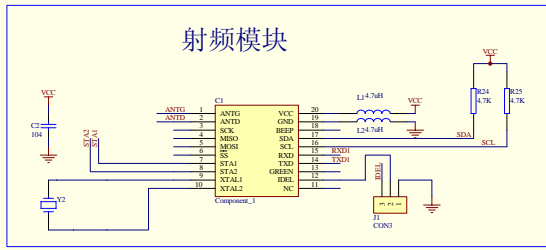

电源

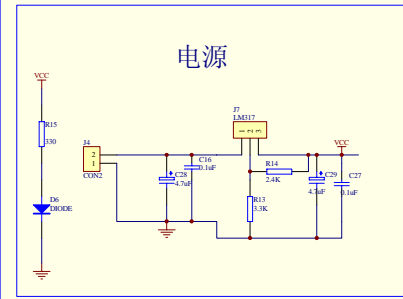

调试下载接口

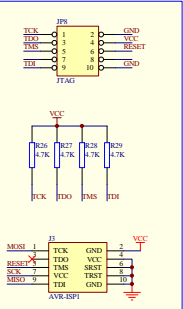

数据存储

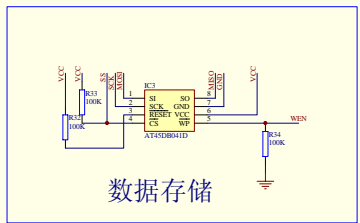

矩阵键盘

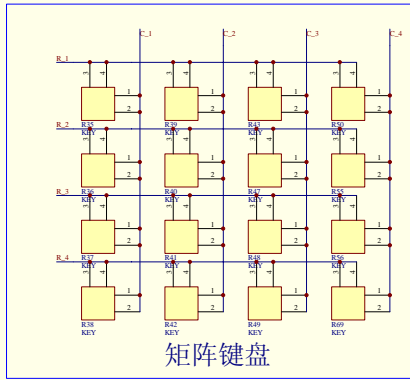

电池供电

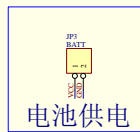

继电器输出

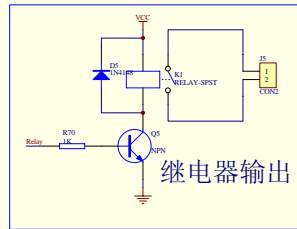

Title		Revision	
Size	Number		
C			
Date	2009-03-20	Sheet of	
File	D:\SL-13\SMART_DOK\SCIPC\BFB_40	Drawn By	